

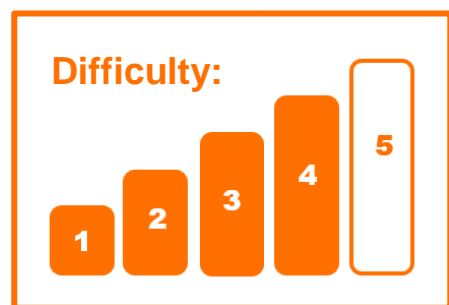

EdBuild

Let's build the EdCrane



The EdCrane EdBuild by [Microbric Education](#) is licensed under a [Creative Commons Attribution-ShareAlike 4.0 International License](#).

EdBuild – the EdCrane

The EdCrane is a remote-controlled crane which can be programmed using the barcodes in this guide plus a downloadable program and controlled with a standard TV or DVD remote control. You will be able to turn the crane clockwise or counter-clockwise on its base. You will also be able to lift and lower the magnetic 'hook'.

Build difficulty rating

The EdCrane is rated a level 4 build.

Difficulty rating	Recommended age	Programming skills needed
1	8+	- Barcodes and remote control
2	8+	- Barcodes and remote control
3	8+	- Barcodes and remote control
4	10+	- Barcodes and remote control AND - EdWare OR - EdPy
5	12+	- EdPy

To successfully complete and operate a build, you will need an understanding of the programming skills listed.

Learn more about programming with Edison at:

- **Barcodes:** Appropriate for ages 4+. No prior experience with programming or robotics is assumed or required.
www.meetedison.com/robot-activities/youre-a-controller/
- **EdWare:** Best suited to students aged 11 to 13. A basic understanding of programming fundamentals may be helpful.
www.meetedison.com/robot-programming-software/edware/
- **EdPy:** Best suited to students aged 13 to 16 years old. A basic understanding of programming fundamentals may be helpful.
www.meetedison.com/robot-programming-software/edpy/

Get set up

Before you begin this build, check that you have everything you need and that you can do the programming required. It's also a good idea to get familiar with how to build with your Edison robot.

What you need

To make the EdCrane, you will need:

- 1 Edison robot
- 1 EdCreate – Edison robot creator's kit
- 1 TV or DVD remote
- 1 print-out of the barcodes sheet (from in this guide)
- Access to a computer with an internet connection

It is recommended that the magnetic hook used in the EdCrane be pre-assembled before beginning this build by and adult or under adult supervision. As this hook uses a real magnet, it is important to keep this hook and the small parts it contains away from children under 3 years of age. Please see the section on building the magnetic hook in this guide for details.

Programming required in this build

To program the EdCrane, you will need to program a remote control with four different commands using the barcodes in this guide.

You will also need to program the Edison robot using either the EdWare or the EdPy robotic programming language. Links to the programs you need are provided in this guide.

Building with Edison



You can build with Edison using an EdCreate creator's kit or any other LEGO brick compatible building system.

Bricks can be attached to the top and bottom of your Edison robot. Pegs can be attached on the sides of Edison. When Edison's wheels are removed, cross axles can be used in the powered sockets.

There are three types of holes on the side of Edison: pin holes, stud holes, and cross axle sockets. Look at the following images to learn more about how to connect and build with Edison.

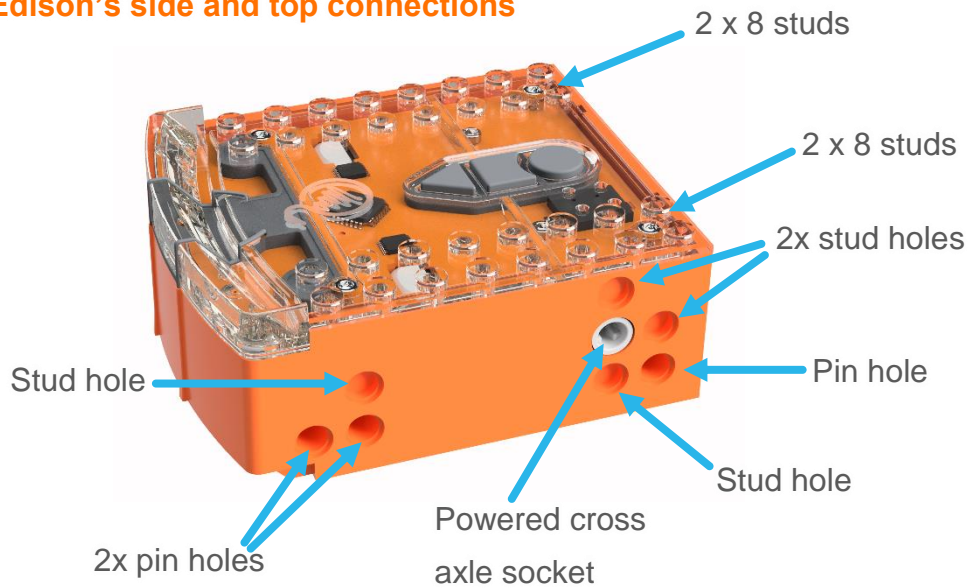
Edison's side and top connections



Hole type	Description	Connects to
Pin hole	A full-depth hole for connecting pegs.	
Stud hole	A hole of normal stud-depth which works with half pegs.	
Cross axle socket	A powered socket which rotates.	

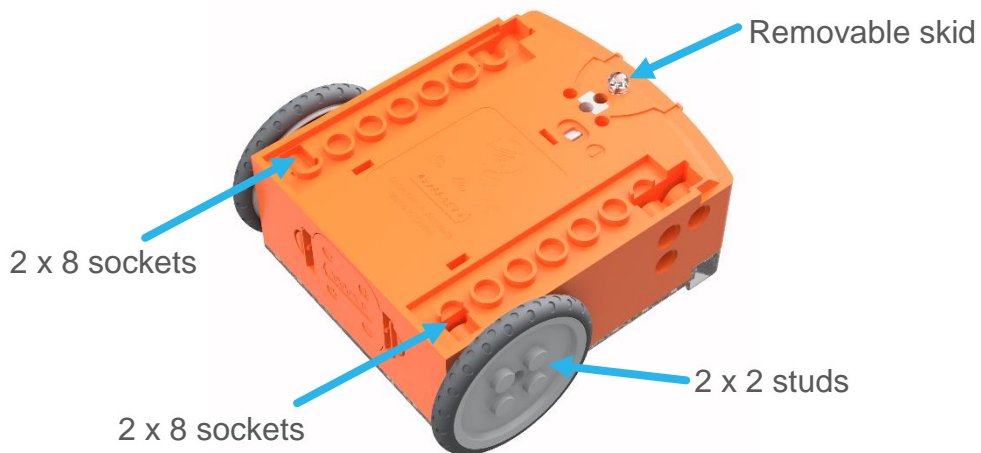

Edison's bottom and wheel connections

Let's build the EdCrane!

The EdCrane is a remote-controlled crane with a magnetic hook which you can raise and lower. The magnetic hook of the EdCrane can lift or lower small ferrous-metal objects, such as metal paper clips or small screws. The EdCreate kit includes a metal peg which can be attached to one of the parts from the EdCreate kit, such as a 3-hole beam, and used with the magnetic hook.

This is what the finished EdCrane, using the magnetic hook, looks like:



Step 1: Program Edison

How the EdCrane is programmed

Before you begin building with the EdCreate parts, you will need to program the remote control codes into the Edison robot using the barcodes in this guide.

Like other EdCreate EdBuilds, the EdCrane responds to a TV or DVD remote control. However, the EdCrane does not use the barcodes in the same way. Instead, the EdCrane uses remote control commands in combination with a downloaded program which you will also need. The downloaded program tells the EdCrane what action to perform when a specific remote code is detected.

You will need to download the remote control program into the Edison robot using either EdWare or EdPy. You can do this before or after you build the crane.

Program the barcodes

The next page has the remote control barcodes for the Edison robot. Print out this page so you can drive your Edison robot over the barcodes.

N.B. – These remote control barcodes are the same ones used to drive Edison robots remotely. As such, when you first pair the robot to a button, it will react by demonstrating the default behaviour of that barcode. For example, ‘TV/DVD remote code #1’ defaults to ‘drive backwards’.

Once you download your program and press the play (triangle) button on the robot, the robot will run the programmed action instead of the barcode default.

Suggested remote control button setup for the EdCrane

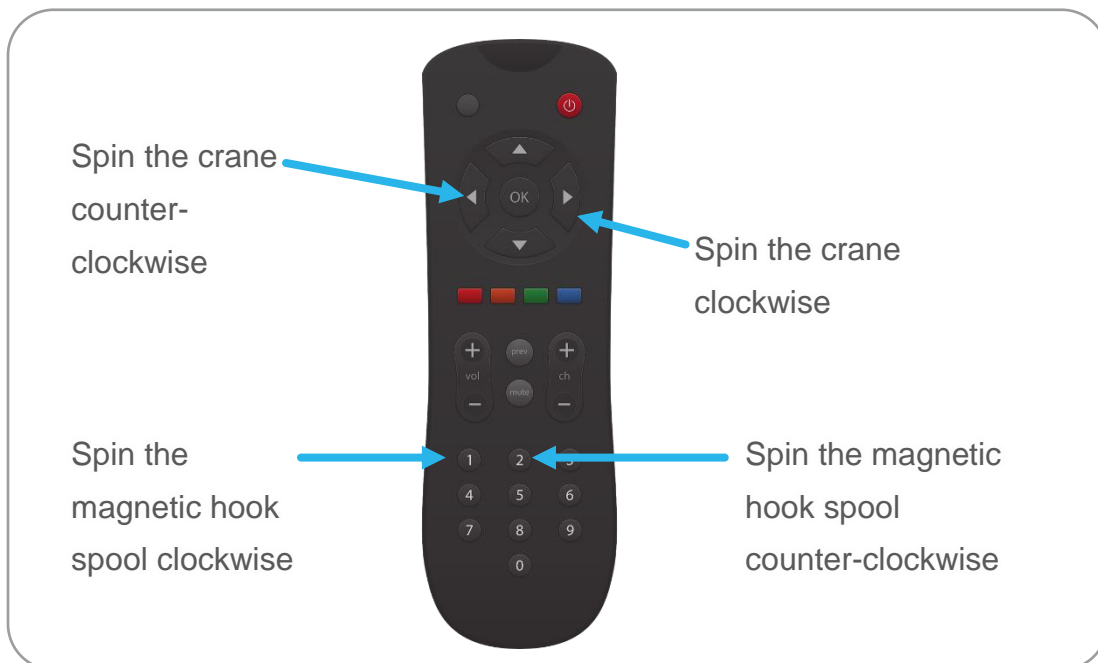

Programming Edison – barcodes

The crane uses one Edison robot which needs to be programmed with four barcodes.

The Edison robot will control the movement of the EdCrane on its base (spin clockwise and spin counter-clockwise) and the movement of the spool which winds the magnetic hook clockwise or counter-clockwise in order to raise or lower the hook. Drive your Edison over the following barcodes, programming each to a button on the remote control.

Reading the barcode

1. Place Edison facing the barcode on the right side
2. Press the record (round) button 3 times
3. Edison will drive forward and scan the barcode
4. Press a button on your TV/DVD remote that you want to activate that function



Barcode – TV/DVD remote code #1 – spin magnetic hook spool clockwise



Barcode – TV/DVD remote code #2 – spin magnetic hook spool counter-clockwise



Barcode – TV/DVD remote code #3 – spin EdCrane counter-clockwise



Barcode – TV/DVD remote code #4 – spin EdCrane clockwise

Programming Edison – downloading a program

You can download the remote control command program into the EdCrane using either EdWare or EdPy.

EdWare – available at www.edwareapp.com

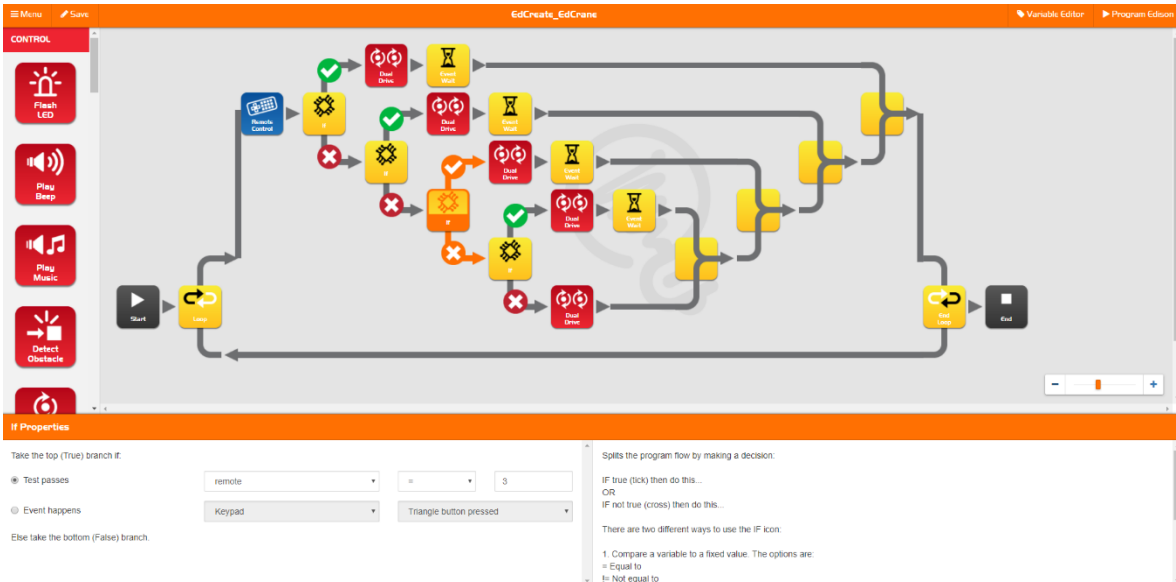

Use the share code www.edwareapp.com/share/sFyJr to open the official EdCrane program in EdWare. You can download this program as-is into your Edison robot.

You can also use this program as a base to make your own EdCrane program.

EdPy – available at www.edpyapp.com

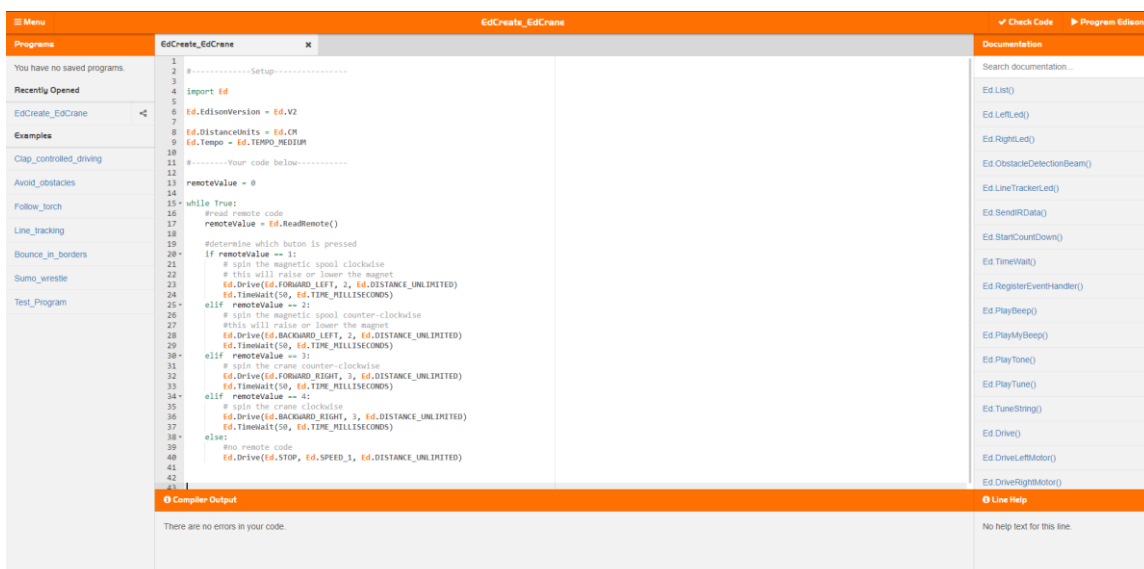

Use the share code www.edpyapp.com/share/99ihb to open the official EdCrane program in EdPy. You can download this program as-is into your Edison robot.

You can also use this program as a base to make your own EdCrane program.

Step 2: Assemble the EdCrane's magnetic hook

Before building the EdCrane, it is recommended that you set up the magnetic hook.

To set up the magnetic hook, you need three of the pieces from the EdCreate kit: the string, the magnet and the hook case.

The magnet and string, along with the metal peg for use with the magnetic hook, come in a small bag which you will need scissors to open.

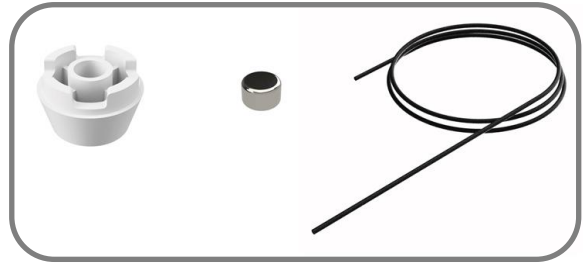

Keep the contents of this bag away from young children to ensure they do not swallow the magnet.

Steps to set up the magnetic hook

1. Feed one end of the string into the top of the hook case.
2. Make a knot in the string near the end of the string. Check that the knot is tight and cannot be pulled back up through the hook case. Double-knot if needed.
3. Push the magnet into the hole in the bottom of the hook case, no more than 0.5cm from the end of the string, trapping the knot and string inside. All of the string needs to be behind the magnet inside of the cavity in the hook case. Trim off excess string below the knot if required. See image:

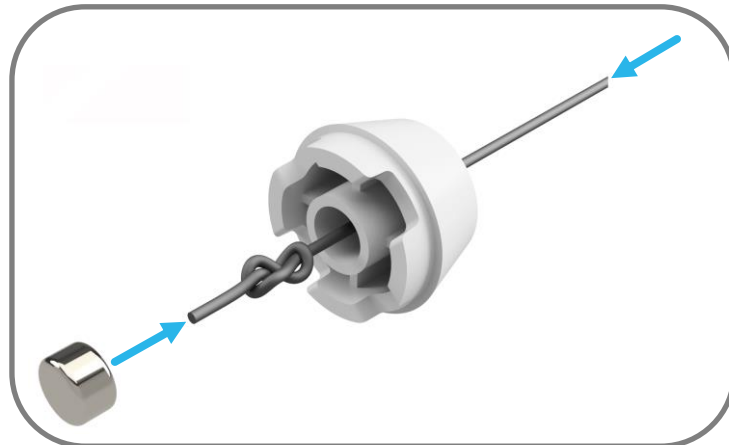

4. Make a second knot in the string near to opposite end of the string (away from the hook). This will be used to anchor that end of the string in place on the spool by sliding it into the groove in the pulley piece. (Refer to step 10 in the build for further details.) See image:



Step 3: Assemble the EdCrane

Follow the illustrations step by step to build the EdCrane.

Reading the instructions:

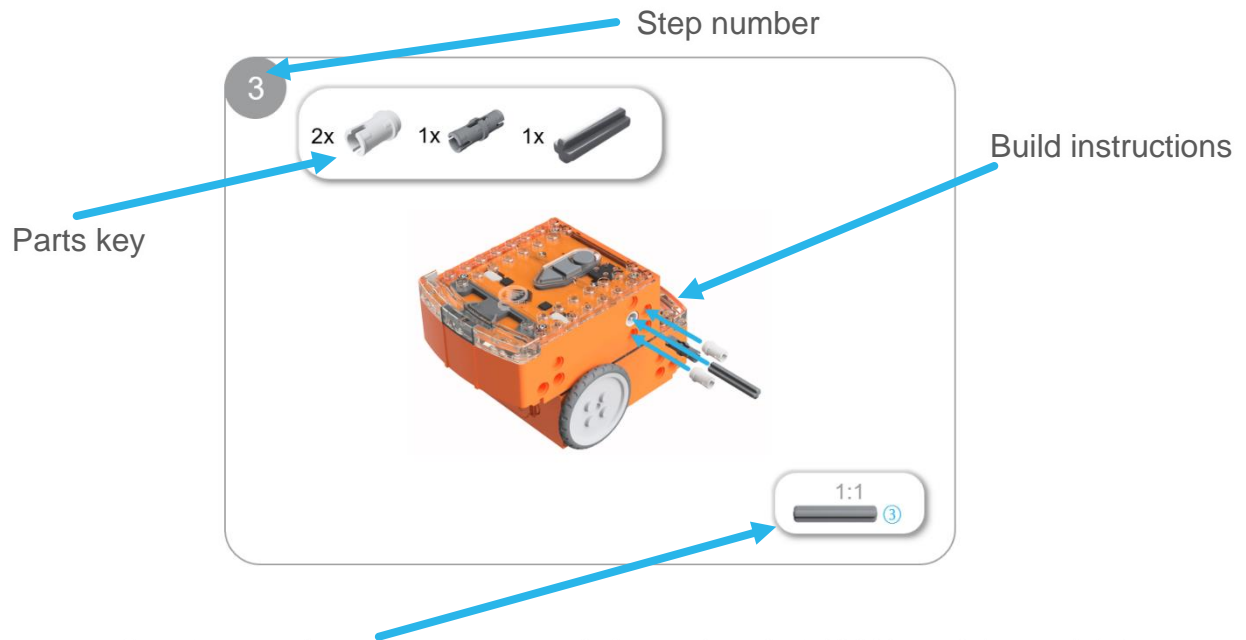

One-to-one piece measurement (when printed at 100% on A4 page). The number in the circle indicates the part's length in number of studs.

1

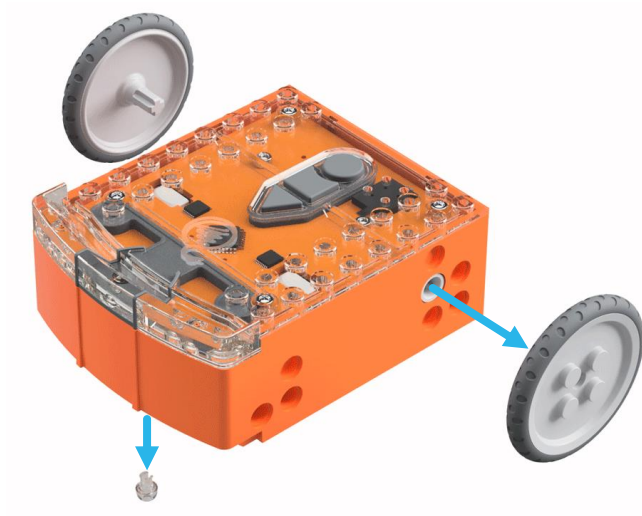

2

3x



2x

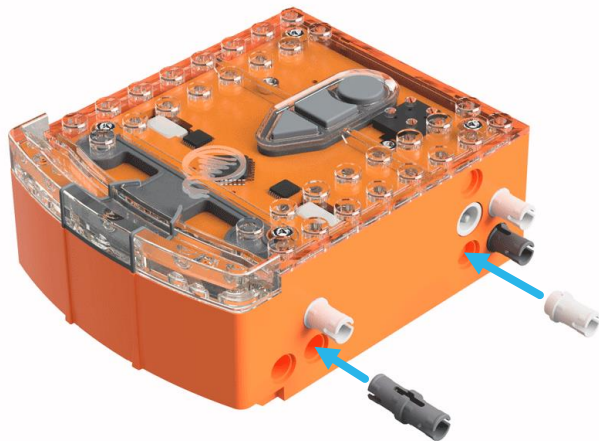

3

1x

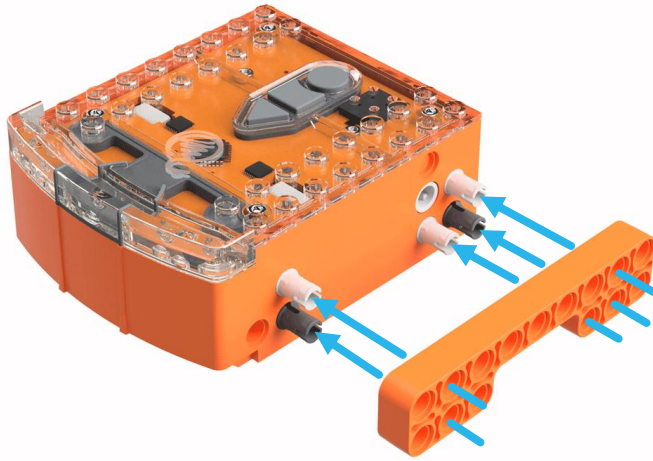
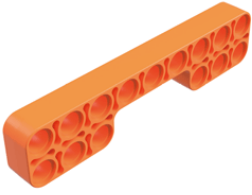

4

4x



1x

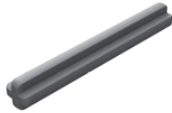

1x

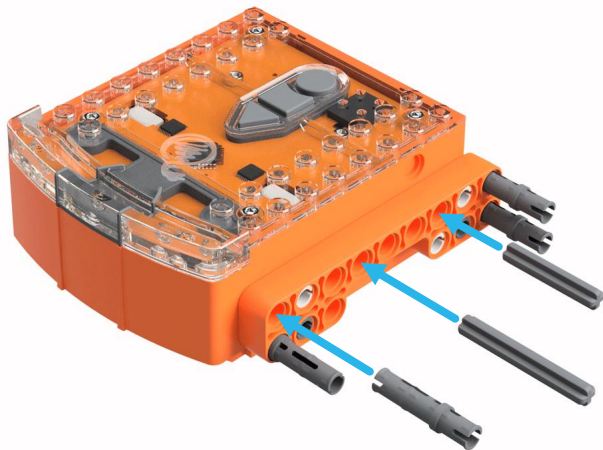
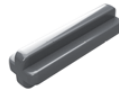

1:1



4



3

5

1x



1x

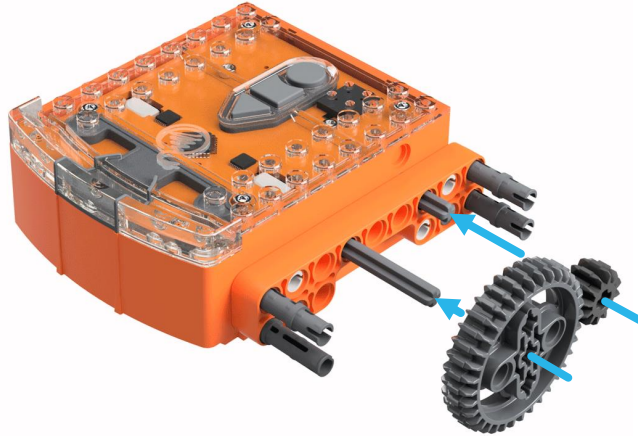

6

1x

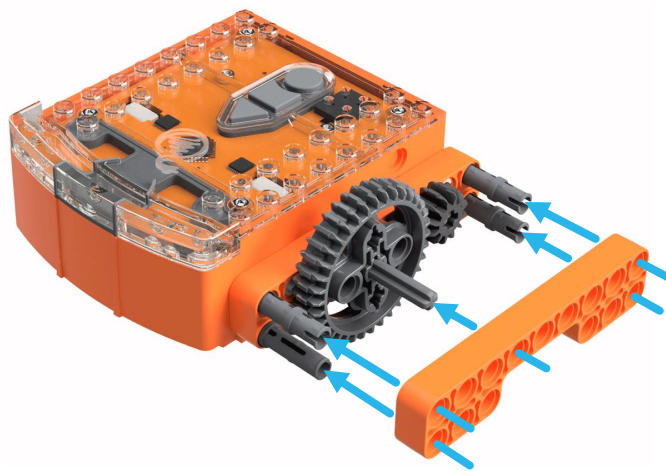
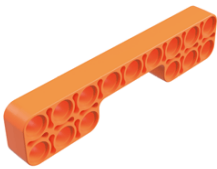

7

1x  1x 

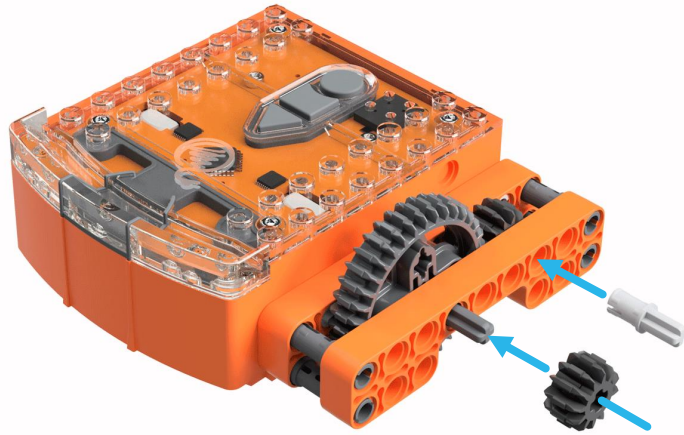

8

2x  4x  1x 

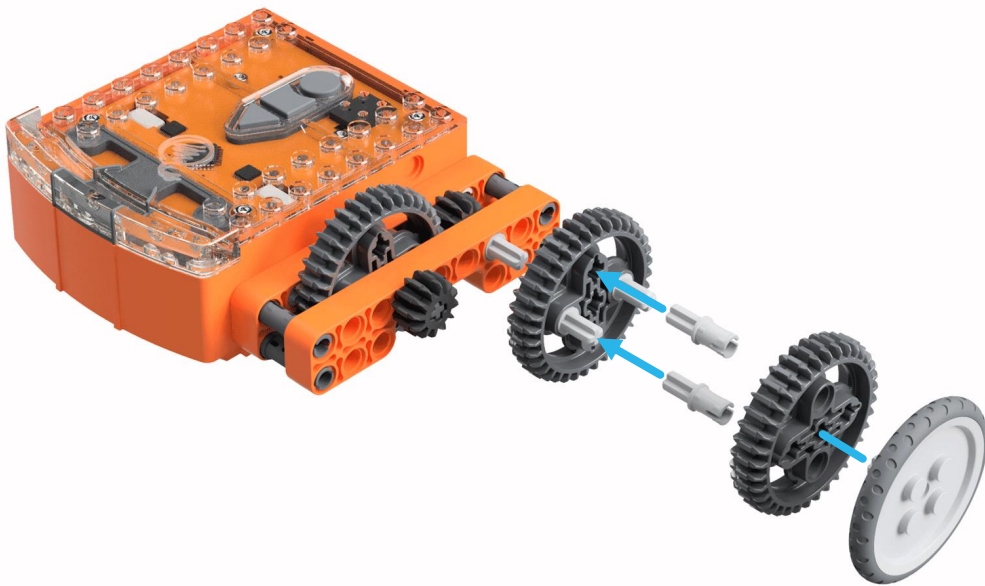

9

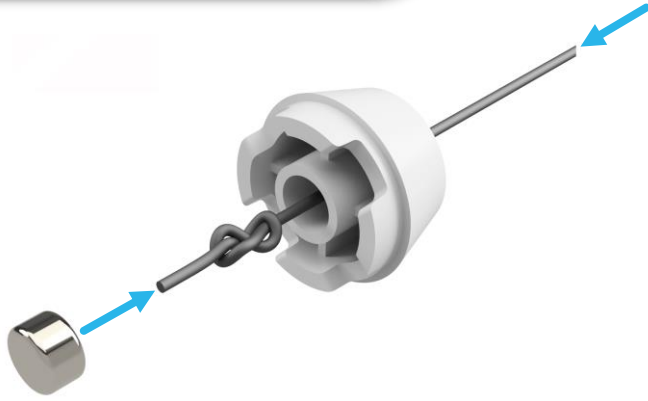
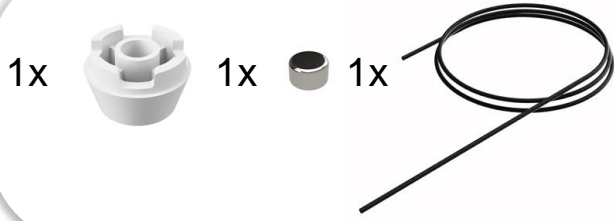

10

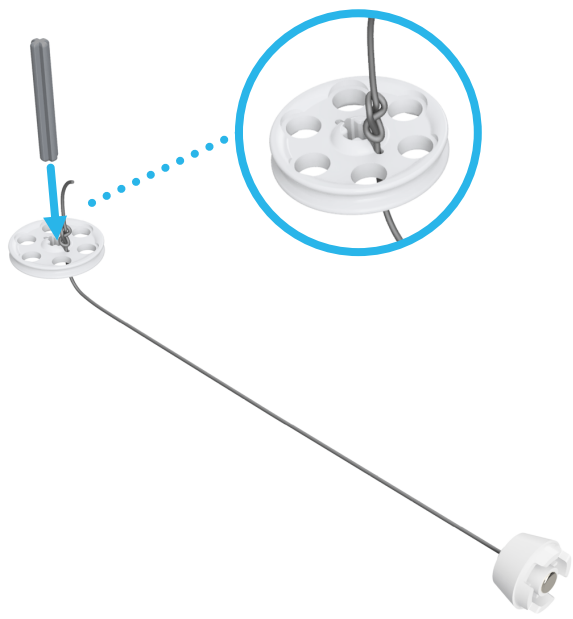
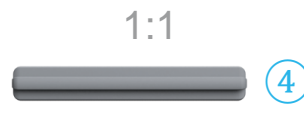
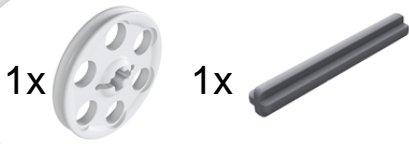

11



12

2x



2x



3x



4x

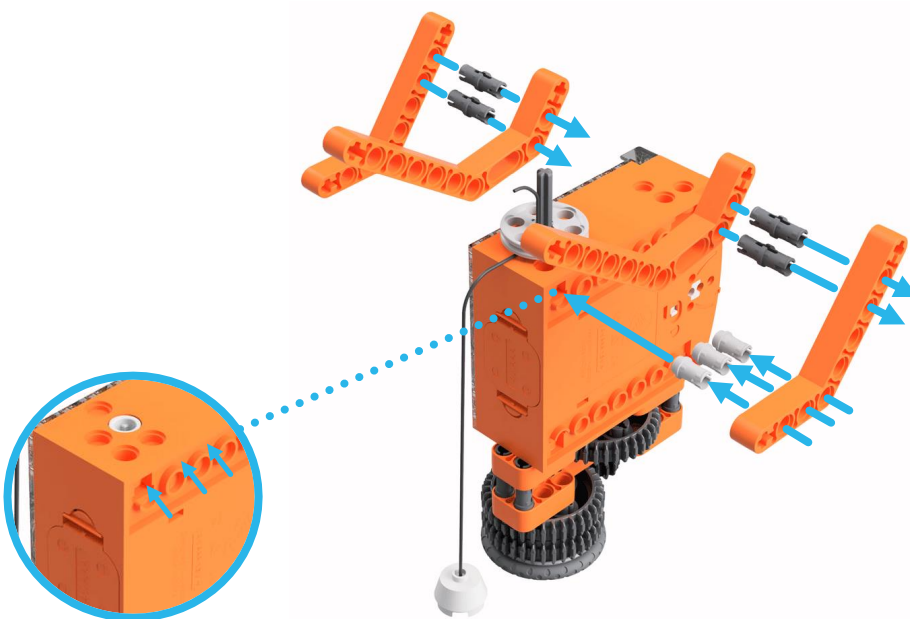

13



14

2x  4x  2x



1:1



6

15

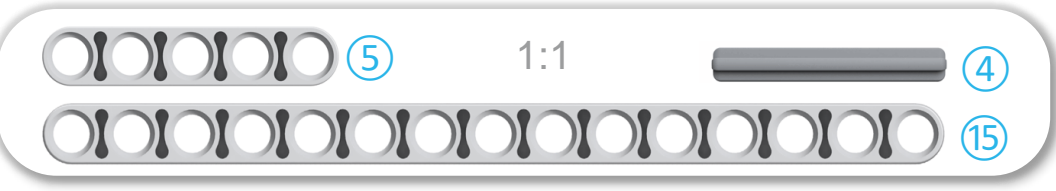
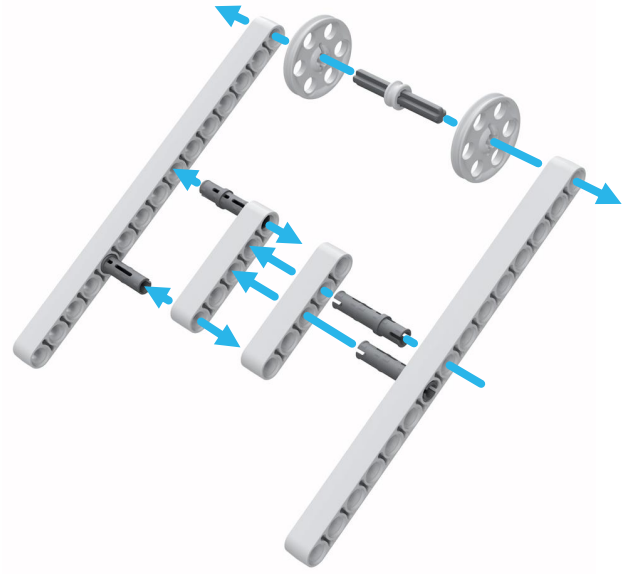
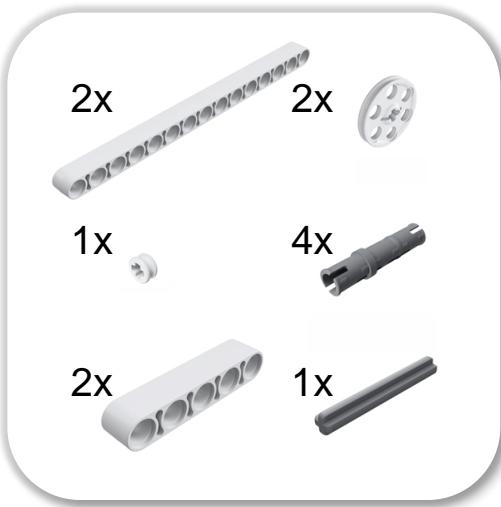

16

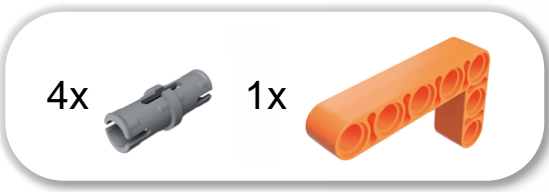

17

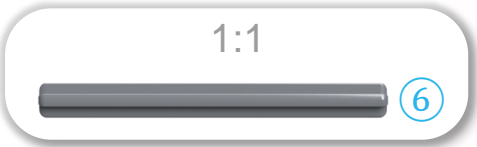
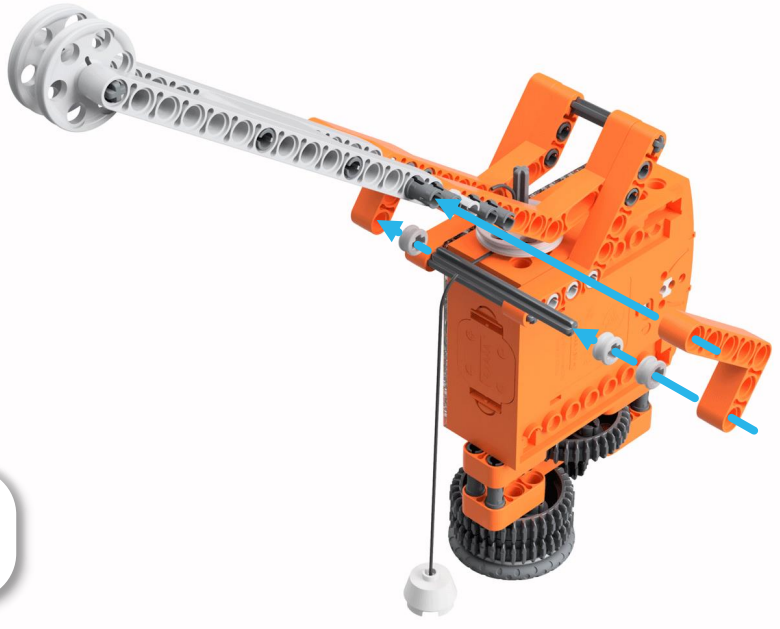
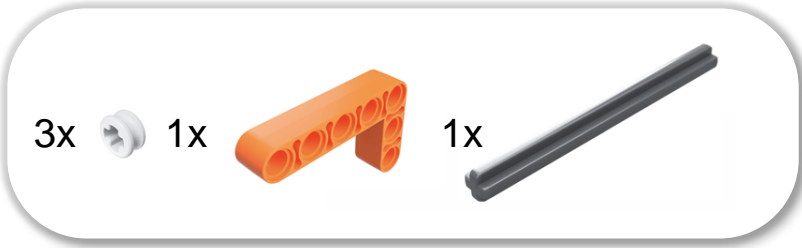

18

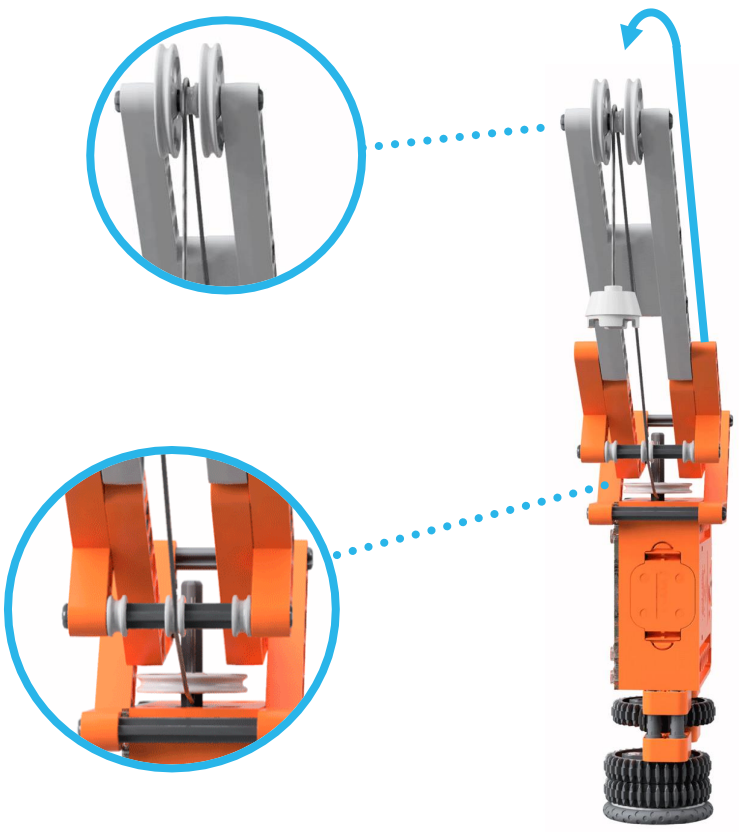

19



20

1x



1x



1:1



3

